

RIGOL

Quick Guide

DS1000Z-E Series Digital Oscilloscope

Aug. 2019

RIGOL (SUZHOU) TECHNOLOGIES INC.

Guaranty and Declaration

Copyright

© 2019 **RIGOL** (SUZHOU) TECHNOLOGIES INC. All Rights Reserved.

Trademark Information

RIGOL is a registered trademark of **RIGOL** (SUZHOU) TECHNOLOGIES INC.

Publication Number

QGA27100-1110

Notices

- **RIGOL** products are covered by P.R.C. and foreign patents, issued and pending.
- **RIGOL** reserves the right to modify or change parts of or all the specifications and pricing policies at the company's sole decision.
- Information in this publication replaces all previously released materials.
- Information in this publication is subject to change without notice.
- **RIGOL** shall not be liable for either incidental or consequential losses in connection with the furnishing, use, or performance of this manual, as well as any information contained.
- Any part of this document is forbidden to be copied, photocopied, or rearranged without prior written approval of **RIGOL**.

Product Certification

RIGOL guarantees that this product conforms to the national and industrial standards in China as well as the ISO9001:2015 standard and the ISO14001:2015 standard. Other international standard conformance certifications are in progress.

Contact Us

If you have any problem or requirement when using our products or this manual, please contact **RIGOL**.

E-mail: service@rigol.com

Website: www.rigol.com

Safety Requirement

General Safety Summary

1. Only the exclusive power cord designed for the instrument and authorized for use within the local country could be used.
2. Ensure that the instrument is safely grounded.
3. Connect the probe correctly.
4. Observe all terminal ratings.
5. Use proper overvoltage protection.
6. Do not operate without covers.
7. Do not insert objects into the air outlet.
8. Use the proper fuse.
9. Avoid circuit or wire exposure.
10. Do not operate the instrument with suspected failures.
11. Provide adequate ventilation.
12. Do not operate in wet conditions.
13. Do not operate in an explosive atmosphere.
14. Keep instrument surfaces clean and dry.
15. Prevent electrostatic impact.
16. Handle with caution.

Safety Notices and Symbols

Safety Notices in this Manual:



WARNING

Indicates a potentially hazardous situation or practice which, if not avoided, will result in serious injury or death.



CAUTION

Indicates a potentially hazardous situation or practice which, if not avoided, could result in damage to the product or loss of important data.

Safety Terms on the Product:

DANGER It calls attention to an operation, if not correctly performed, could result in injury or hazard immediately.

WARNING It calls attention to an operation, if not correctly performed, could result in potential injury or hazard.

CAUTION It calls attention to an operation, if not correctly performed, could result in damage to the product or other devices connected to the product.

Safety Symbols on the Product:



Hazardous
Voltage



Safety
Warning



Protective
Earth
Terminal



Chassis
Ground



Test
Ground

Measurement Category

Measurement Category

DS1000Z-E series digital oscilloscopes can make measurements in Measurement Category I.



WARNING

This oscilloscope can only be used for measurements within its specified measurement categories.

Measurement Category Definitions

Measurement category I is for measurements performed on circuits not directly connected to MAINS. Examples are measurements on circuits not derived from MAINS, and specially protected (internal) MAINS derived circuits. In the latter case, transient stresses are variable; for that reason, the transient withstand capability of the equipment is made known to the user.

Measurement category II is for measurements performed on circuits directly connected to the low voltage installation. Examples are measurements on household appliances, portable tools and similar equipment.

Measurement category III is for measurements performed in the building installation. Examples are measurements on distribution boards, circuit-breakers, wiring, including cables, bus-bars, junction boxes, switches, socket-outlets in the fixed installation, and equipment for industrial use and some other equipment, for example. Stationary motors with permanent connection to the fixed installation.

Measurement category IV is for measurements performed at the source of the low-voltage installation. Examples are electricity meters and measurements on primary overcurrent protection devices and ripple control units.

Ventilation Requirement

This oscilloscope uses fan to force cooling. Please make sure that the air intake and exhaust areas are free from obstructions and have free air. When using the oscilloscope in a bench-top or rack setting, provide at least 10 cm clearance beside, above and behind the instrument for adequate ventilation.



WARNING

Inadequate ventilation may cause temperature increase which would damage the instrument. So please keep the instrument well ventilated during operation and inspect the intake and fan regularly.

Working Environment

Temperature

Operating: 0°C to +50°C

Non-operating: -40°C to +70°C

Humidity

0°C to +30°C: ≤95% relative humidity

+30°C to +40°C: ≤75% relative humidity

+40°C to +50°C: ≤45% relative humidity



WARNING

To avoid short circuit inside the instrument or electric shock, please do not operate in humid environment.

Altitude

Operating: below 3 km

Non-operating: below 15 km

Installation (Overvoltage) Category

This product is powered by mains conforming to installation (overvoltage) category II.



WARNING

Make sure that no overvoltage (such as that caused by thunderbolt) can reach the product, or else the operator might expose to danger of electric shock.

Installation (Overvoltage) Category Definitions

Installation (overvoltage) category I refers to signal level which is applicable to equipment measurement terminals connected to the source circuit. In these terminals, precautions are done to limit the transient voltage to the corresponding low level.

Installation (overvoltage) category II refers to the local power distribution level which is applicable to equipment connected to the AC line (AC power).

Pollution Degree

Degree 2

Pollution Degree Definitions

Pollution degree 1: No pollution or only dry, non-conductive pollution occurs. The pollution has no influence. For example: a clean room or air-conditioned office environment.

Pollution degree 2: Normally only dry, non-conductive pollution occurs. Occasionally a temporary conductivity caused by condensation may occur. For example: general indoor environment.

Pollution degree 3: Conductive pollution occurs, or dry, non-conductive pollution occurs which becomes conductive due to condensation which is expected. For example: Sheltered outdoor environment.

Pollution degree 4: Pollution that generates persistent conductivity through conductive dust, rain, or snow. For example: outdoor locations.

Safety Class

Class 1 – Grounded Product

Care and Cleaning

Care

Do not store or leave the instrument where it may be exposed to direct sunlight for long periods of time.

Cleaning

Clean the instrument regularly according to its operating conditions.

1. Disconnect the instrument from all power sources.
2. Clean the external surfaces of the instrument with a soft cloth dampened with mild detergent or water. Avoid having any water or other objects into the chassis via the heat dissipation hole. When cleaning the LCD, take care to avoid scarifying it.



CAUTION

To avoid damage to the instrument, do not expose it to caustic liquids.



WARNING

To avoid short-circuit resulting from moisture or personal injuries, ensure that the instrument is completely dry before connecting it to the power supply.

Environmental Considerations

The following symbol indicates that this product complies with the WEEE Directive 2002/96/EC.



Product End-of-Life Handling

The equipment may contain substances that could be harmful to the environment or human health. To avoid the release of such substances into the environment and avoid harm to human health, we recommend you to recycle this product appropriately to ensure that most materials are reused or recycled properly. Please contact your local authorities for disposal or recycling information.

Document Overview

This manual is used to guide users to quickly get familiar with the front panel, rear panel, user interface and basic operation method of DS1000Z-E series digital oscilloscope. You can download the newest version of the manual from **RIGOL** official website (www.rigol.com).

Format Conventions in this Manual:

1. Key

The front panel keys are denoted by the format of "Key Name (Bold) + Text Box". For example, **Utility** denotes the "Utility" key.





2. Menu

The menu softkeys are denoted by the format of "Menu Word (Bold) + Character Shading". For example, **System** denotes the "System" menu under **Utility**.

3. Operation Step

The next step of operation is denoted by an arrow "→". For example, **Utility** → **System** denotes that first press **Utility** on the front panel and then press **System**.

4. Knob

Label	Knob
HORIZONTAL  SCALE	Horizontal Scale Knob
HORIZONTAL  POSITION	Horizontal Position Knob
VERTICAL  SCALE	Vertical Scale Knob
VERTICAL  POSITION	Vertical Position Knob
TRIGGER  LEVEL	Trigger Level Knob

Content Conventions in this Manual:

DS1000Z-E series includes the following models. Unless otherwise noted, this manual takes DS1202Z-E as an example to illustrate the front panel, rear panel, user interface and basic operation methods of DS1000Z-E series.

Model	Analog Bandwidth	Number of Analog Channels
DS1202Z-E	200 MHz	2

Contents

Guaranty and Declaration	I
Safety Requirement	II
General Safety Summary	II
Safety Notices and Symbols	II
Measurement Category	III
Ventilation Requirement	III
Working Environment	IV
Care and Cleaning	V
Environmental Considerations	VI
Document Overview	VI
Quick Start	1
General Inspection	1
Appearance and Dimensions	2
To Prepare for Operation	3
To Adjust the Supporting Legs	3
To Connect to AC Power Supply	3
Turn-on Checkout	4
To Connect the Probe	4
Function Inspection	5
Probe Compensation	6
Front Panel Overview	7
Rear Panel Overview	8
Front Panel Function Overview	10
VERTICAL	10
HORIZONTAL	11
TRIGGER	11
CLEAR	12
AUTO	12
RUN/STOP	12
SINGLE	12
Multifunction Knob	13
Function Menus	13
Print	14
User Interface	15
Parameter Setting Method	18
To Use the Security Lock	18
To Use the Built-in Help System	19
Troubleshooting	20

Quick Start

General Inspection

1. **Inspect the packaging**

If the packaging has been damaged, do not dispose the damaged packaging or cushioning materials until the shipment has been checked for completeness and has passed both electrical and mechanical tests.

The consigner or carrier shall be liable for the damage to the instrument resulting from shipment. **RIGOL** would not be responsible for free maintenance/rework or replacement of the instrument.

2. **Inspect the instrument**

In case of any mechanical damage, missing parts, or failure in passing the electrical and mechanical tests, contact your **RIGOL** sales representative.

3. **Check the accessories**

Please check the accessories according to the packing lists. If the accessories are damaged or incomplete, please contact your **RIGOL** sales representative.

Appearance and Dimensions

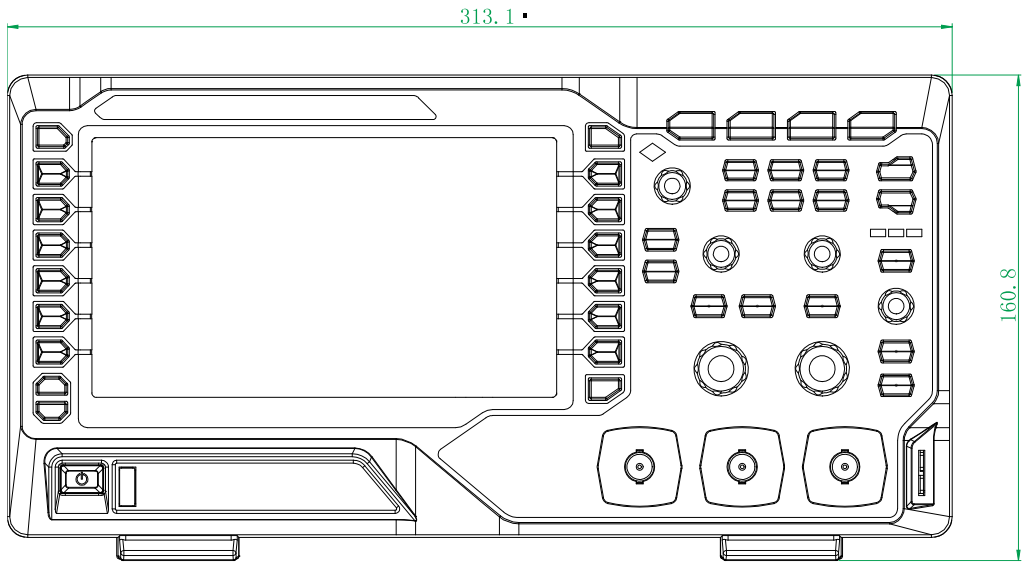

Figure 1 Front View

Unit: mm

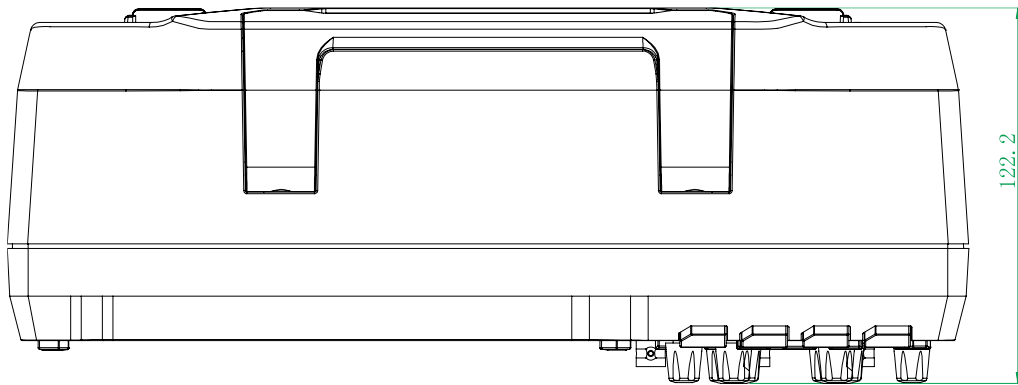



Figure 2 Top View

Unit: mm

Turn-on Checkout

When the oscilloscope is connected to power, press the Power key  at the lower-left corner of the front panel to start the oscilloscope. During the start-up process, the oscilloscope performs a series of self-test items. After the self-test, the welcome screen is displayed. The instrument is installed with the trial versions of the options before leaving factory and the remaining time is about 2,000 minutes. The "Installed Options" dialog box will be displayed if your instrument has currently installed the trial versions of options. From this dialog box you can view the name, detail, version and remaining trial time of the option currently installed.

To Connect the Probe

RIGOL provides passive probe for DS1000Z-E series. For the model of the probes, please refer to *DS1000Z-E Series Datasheet*. For detailed technical information of the probes, please refer to corresponding Probe User's Guide.

Connect the Probe:

1. Connect the BNC terminal of the probe to an analog channel input of the oscilloscope on the front panel.
2. Connect the ground alligator clip of the probe to the circuit ground terminal and then connect the probe tip to the circuit point under test.

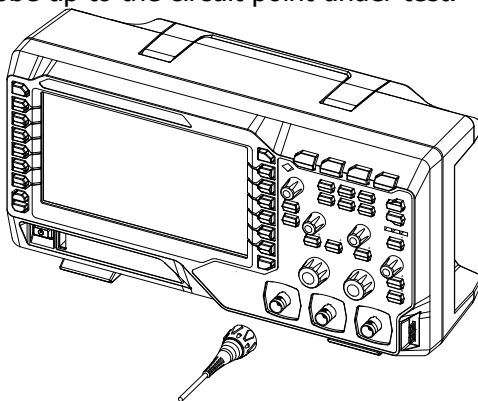

Figure 5 To Connect the Passive Probe

After you connect the passive probe, check the probe function and probe compensation adjustment before making measurements. For detailed procedures, refer to "**Function Inspection**" and "**Probe Compensation**" sections in this manual.

Function Inspection

1. Press **Storage** → **Default** to restore the oscilloscope to its default configuration.
2. Connect the ground alligator clip of the probe to the "Ground Terminal" as shown in the figure below.
3. Use the probe to connect the input terminal of CH1 and the "Compensation Signal Output Terminal" of the oscilloscope.

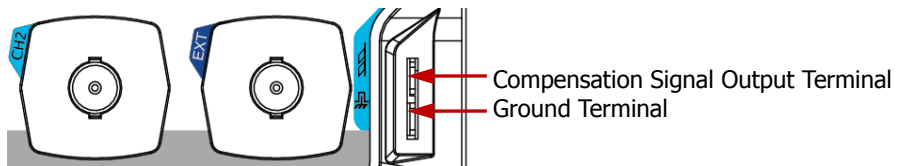

Figure 6 To Use the Compensation Signal

4. Set the attenuation on the probe to 10X. Then press **AUTO**.
5. Observe the waveform on the display. In normal condition, the display should be a square waveform as shown in the figure below:

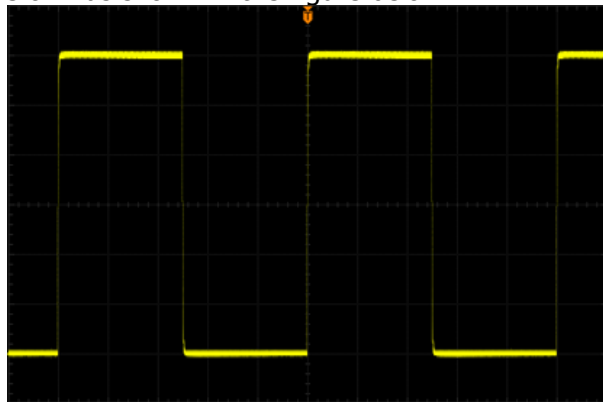

Figure 7 Square Waveform

6. Use the same method to test the other channels. If the square waveforms actually shown do not match that in the figure above, please perform "**Probe Compensation**".



WARNING

To avoid electric shock during the use of probe, please make sure that the insulated wire of the probe is in good condition. Do not touch the metallic part of the probe when the probe is connected to high voltage source.

Tip

The signal output from the probe compensation connector can only be used for probe compensation adjustment and cannot be used for calibration.

Probe Compensation

When the probes are used for the first time, you should compensate the probes to match the input channels of the oscilloscope. Non-compensated or poorly compensated probes may cause measurement inaccuracy or errors. The probe compensation procedures are as follows:

1. Perform Step 1, 2, 3 and 4 specified in "**Function Inspection**".
2. Check the displayed waveforms and compare them with the waveforms in the following figure.

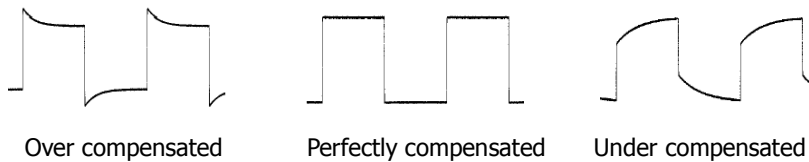

Figure 8 Probe Compensation

3. Use a nonmetallic driver to adjust the low-frequency compensation adjustment hole on the probe until the displayed waveform is displayed as "Perfectly compensated" in the figure above.

Front Panel Overview

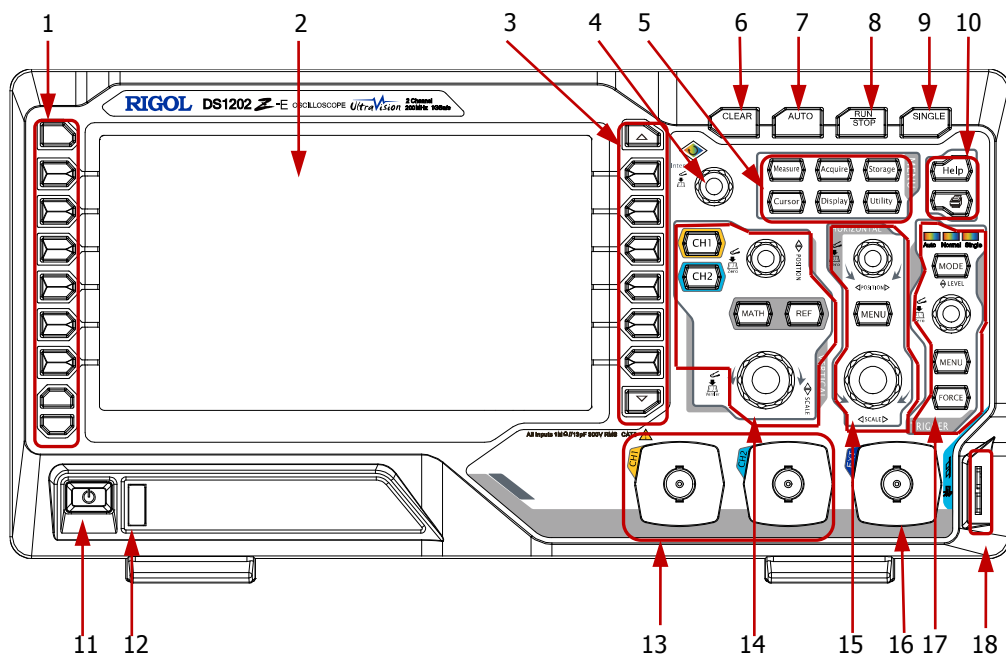

Figure 9 Front Panel Overview

Table 1 Front Panel Description

No.	Description	No.	Description
1	Measurement Menu Softkeys	10	Help/Print
2	LCD	11	Power Key
3	Function Menu Softkeys	12	USB Host Interface
4	Multifunction Knob	13	Analog Channel Input
5	Common Operation Keys	14	VERTICAL Control Area
6	CLEAR	15	HORIZONTAL Control Area
7	AUTO	16	External Trigger Input
8	RUN/STOP	17	TRIGGER Control Area
9	SINGLE	18	Probe Compensation Signal Output Terminal/Ground Terminal

Rear Panel Overview

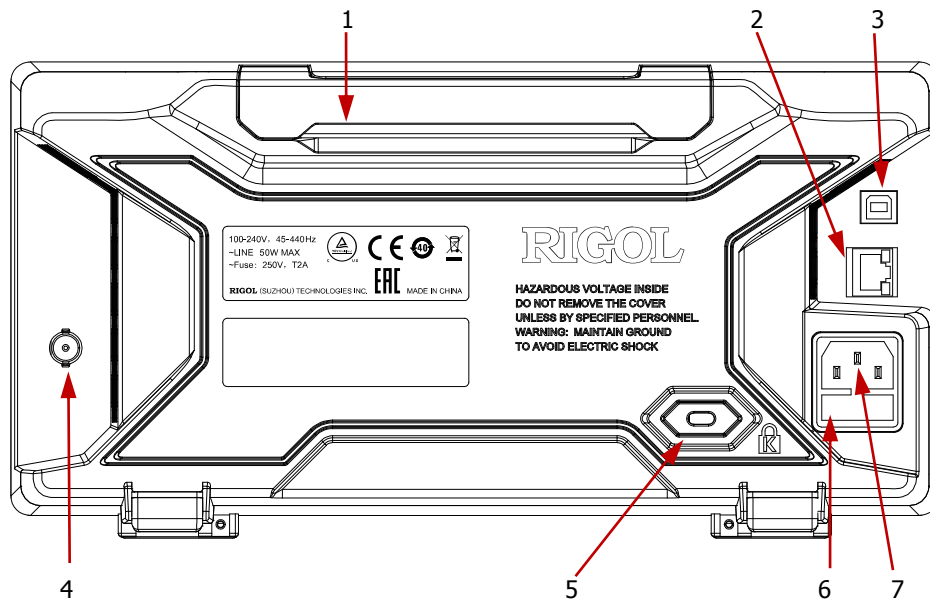

Figure 10 Rear Panel Overview

1. Handle

Pull up the handle vertically for easy carrying of the instrument. When you do not need the handle, press it down.

2. LAN

Connect the instrument to the network via this interface for remote control. This oscilloscope conforms to the LXI CORE 2011 DEVICE class instrument standards and can quickly build test system with other instruments.

3. USB DEVICE

You can connect the oscilloscope to a PictBridge printer or PC via this interface. When a PC is connected, users can send SCPI commands using the PC software or control the oscilloscope via user-defined programming. When a printer is connected, users can print the waveforms displayed on the screen using the printer.

4. Trigger Out and Pass/Fail

● Trigger Out:

The oscilloscope can output a signal that can reflect the current capture rate of the oscilloscope at each trigger via this interface. Connect the signal to a waveform display device to measure the frequency of the signal. The measurement result is equal to the current capture rate.

- **Pass/Fail:**

The instrument will output a negative pulse via this connector when a failed waveform is detected during the pass/fail test. The instrument continuously outputs a low level via this connector when no failed waveform is detected.

5. Lock Hole

You can lock the instrument to a fixed location by using the security lock (please purchase it yourself) via the lock hole.

6. Fuse

If a new fuse is required, please use the specified fuse (250V, T2A). The operation method is as follows:

- a) Turn off the instrument, disconnect the power, and then remove the power cord.
- b) Insert a small straight screwdriver into the slot at the power cord connector and pry out the fuse holder gently.
- c) Take out the fuse and replace it with a specified fuse. Then, install the fuse holder.

7. AC Power Cord Connector

AC power input terminal. The power requirements of this oscilloscope are 100-240 V, 45-440 Hz. Use the power cord provided with the accessories to connect the instrument to AC power. Then, you can press the Power key on the front panel to start the instrument.

Front Panel Function Overview

VERTICAL

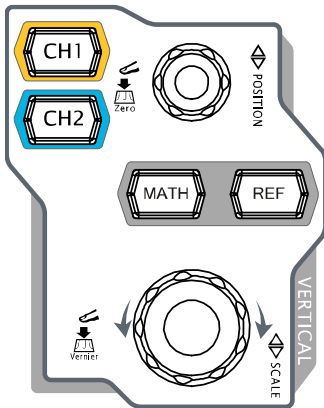

CH1, **CH2**: analog channel setting keys. The 2 channels are marked by different colors which are also used to mark both the corresponding waveforms on the screen and the channel input connectors. Press any key to open the corresponding channel menu and press again to turn off the channel.

MATH: press **MATH** → **Math**, you can open the math operation menu under which $A+B$, $A-B$, $A \times B$, A/B , FFT, $A \& B$, $A || B$, A^B , $!A$, Intg, Diff, Sqrt, Lg, Ln, Exp and Abs are provided. You can also press **MATH** to open the decoding menu and set the decoding options.

REF: press this key to enable the reference waveform function to compare the waveform actually measured with the reference waveform.

Vertical **POSITION**: modify the vertical position of the current channel waveform. Turn clockwise to increase the position and turn counterclockwise to decrease. During the modification, the waveform would move up and down and the position message (e.g. **POS: 216.0mV**) at the lower-left corner of the screen would change accordingly. Press down this knob to quickly reset the vertical position to zero.

VERTICAL **SCALE**: modify the vertical scale of the current channel. Turn clockwise to decrease the scale and turn counterclockwise to increase. During the modification, the amplitude of the waveform would enlarge or reduce and the scale information (e.g. **1 μ 200mV**) at the lower side of the screen would change accordingly. Press down this knob to quickly switch the vertical scale adjustment modes between "Coarse" and "Fine".

Tip

How to set the vertical scale and vertical position of each channel?

The 2 channels of DS1000Z-E use the same **VERTICAL** **POSITION** and **VERTICAL** **SCALE** knobs. If you want to set the vertical scale and vertical position of a certain channel, please press **CH1** or **CH2** at first to select the desired channel. Then rotate the **VERTICAL** **POSITION** and **VERTICAL** **SCALE** knobs to set the values.

HORIZONTAL

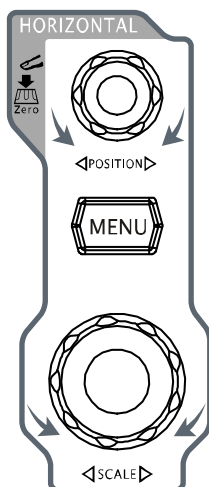

HORIZONTAL  **POSITION**: modify the horizontal position. The trigger point would move left or right relative to the center of the screen when you rotate the knob. During the modification, waveforms of all the channels would move left or right and the horizontal position message (e.g. **D** -200.000000ns) at the upper-right corner of the screen would change accordingly. Press down this knob to quickly reset the horizontal position (or the delayed sweep position).

MENU: press this key to open the horizontal control menu where you can turn on or off the delayed sweep function and switch between different time base modes.

HORIZONTAL  **SCALE**: modify the horizontal time base. Turn clockwise to reduce the time base and turn counterclockwise to increase the time base. During the modification, waveforms of all the channels will be displayed in expanded or compressed mode and the time base message (e.g. **H** 500ns) at the upper side of the screen would change accordingly. Press down this knob to quickly switch to delayed sweep state.

TRIGGER

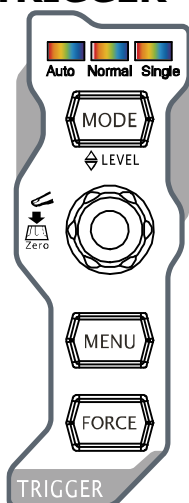

MODE: press this key to switch the trigger mode to **Auto**, **Normal** or **Single** and the corresponding state backlight of the current trigger mode would be illuminated.

TRIGGER  **LEVEL**: modify the trigger level. Turn clockwise to increase the level and turn counterclockwise to reduce the level. During the modification, the trigger level line would move up and down and the value in the trigger level message box (e.g. **Trig Level : 428mV**) at the lower-left corner of the screen would change accordingly. Press down the knob to quickly reset the trigger level to zero point.

MENU: press this key to open the trigger operation menu. This oscilloscope provides various trigger types; for the details, please refer to the introduction in *DS1000Z-E User Guide*.

FORCE: press this key to generate a trigger signal forcibly.

CLEAR

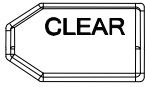

Press this key to clear all the waveforms on the screen. If the oscilloscope is in "RUN" state, new waveforms will still be displayed.

AUTO

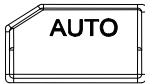

Press this key to enable the waveform auto setting function. The oscilloscope will automatically adjust the vertical scale, horizontal time base and trigger mode according to the input signal to realize optimum waveform display.

Note: Waveform auto setting function requires that the frequency of sine is no lower than 41 Hz; the duty cycle should be greater than 1% and the amplitude must be at least 20 mVpp for square. Otherwise, the Waveform auto setting function may be invalid and the quick parameter measurement function displayed in the menu will also be unavailable.

RUN/STOP

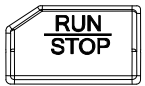

Press this key to "RUN" or "STOP" waveform sampling. In the "RUN" state, the key is illuminated in yellow. In the "STOP" state, the key is illuminated in red.

SINGLE

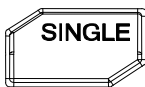

Press this key to set the trigger mode to "Single". In single trigger mode, press **FORCE** to generate a trigger signal immediately.

Multifunction Knob



Adjust waveform brightness:

In non-menu-operation mode, turn this knob to adjust the brightness of waveform display. The adjustable range is from 0% to 100%. Turn clockwise to increase the brightness and counterclockwise to reduce. Press down this knob to reset the brightness to 60%.

You can also press **Display** → **Intensity** and use the knob to adjust the waveform brightness.

Multifunctional:

In menu operation, the backlight of the knob goes on. Press any menu softkey and rotate the knob to select the submenus under this menu and then press down the knob to select the current submenu. It can also be used to modify parameters (please refer to the introduction in "**Parameter Setting Method**") and input filename.

Function Menus

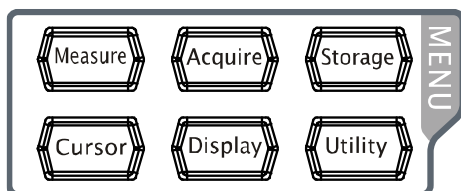

Measure: press this key to open the measurement setting menu. You can set the measurement source, turn on or off the frequency counter, all measure, statistic function and etc. Press **MENU** at the left of the screen to switch the measurement menus of 37 waveform parameters. Then, press down the corresponding menu softkey to quickly realize one-key measurement and the measurement result will be displayed at the bottom of the screen.

Acquire: press this key to enter the sample setting menu to set the acquisition mode, $\text{Sin}(x)/x$ and memory depth of the oscilloscope.

Storage: press this key to enter file store and recall interface. The storable file types include picture, traces, waveforms, setups, CSV and parameters. Internal and external storage as well as disk management are also supported.

Cursor: press this key to enter the cursor measurement menu. The oscilloscope provides four cursor modes: manual, track, auto and XY. Note that XY cursor mode is only available when the horizontal time base is set to XY.

Display: press this key to enter display setting menu to set the display type, persistence time, wave intensity, grid type and grid brightness.

Utility: press this key to enter the system function setting menu to set the system-related functions or parameters, such as the I/O, sound and language. Besides, some advanced functions (such as the pass/fail test, waveform record, etc.) are also supported.

Print

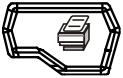

Press this key to print the screen or save the screen to a USB storage device.

- If a PictBridge printer is connected currently and the printer is in idle state, pressing this key will execute the print operation.
- If no printer is connected but a USB storage device is inserted, pressing this key can save the screen to the USB storage device in the specified format.
- If both a printer and a USB storage device are connected at the same time, the printer enjoys higher priority when pressing this key.

User Interface

DS1000Z-E provides 7.0 inch WVGA (800*480) TFT LCD.

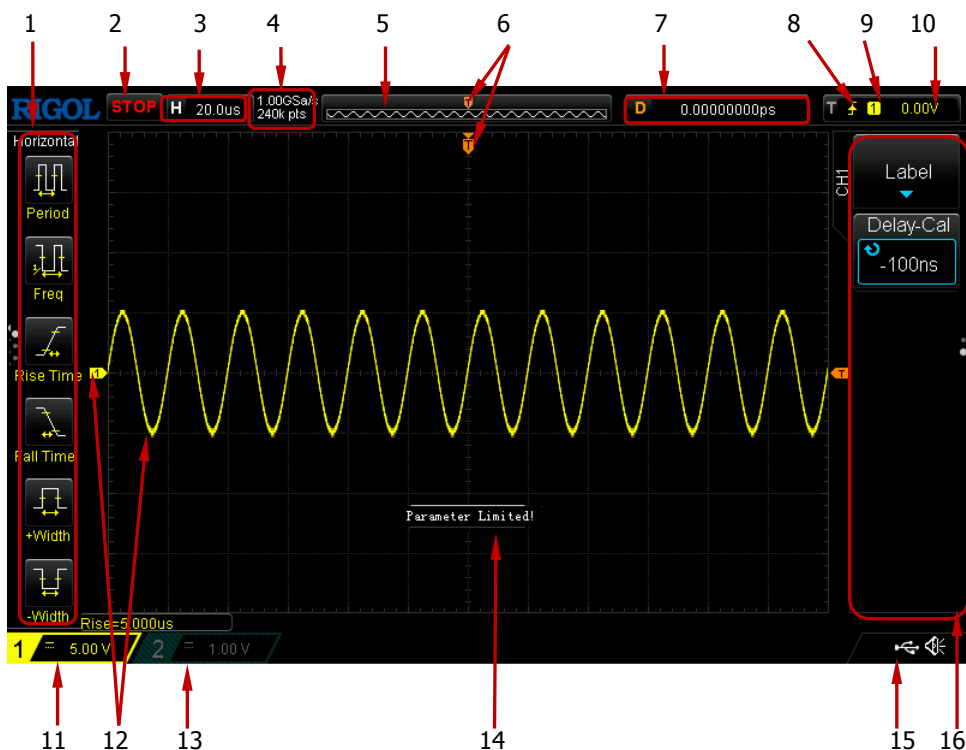

Figure 11 User Interface

1. Auto Measurement Items

Provide 20 horizontal (HORIZONTAL) and 17 vertical (VERTICAL) measurement parameters. Press the softkey at the left of the screen to activate the corresponding measurement item. Press **MENU** continuously to switch between the horizontal and vertical parameters.

2. Status

Available states include RUN, STOP, T'D (triggered), WAIT and AUTO.

3. Horizontal Time Base

- Represent the time per grid on the horizontal axis on the screen.
- Use **HORIZONTAL**  **SCALE** to modify this parameter. The range available is from 5 ns to 50 s.

4. Sample Rate/Memory Depth

- Display the current sample rate and memory depth of the oscilloscope.
- The sample rate and memory depth will change in accordance with the

horizontal time base.

5. Waveform Memory

Provide the schematic diagram of the memory position of the waveform currently on the screen.

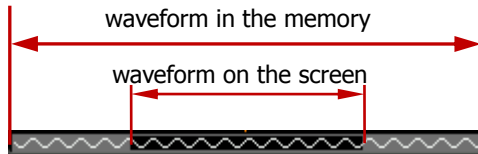

6. Trigger Position

Display the trigger position of the waveform in the waveform memory and on the screen.

7. Horizontal Position

Use **HORIZONTAL**  **POSITION** to modify this parameter. Press down the knob to automatically set the parameter to zero.





8. Trigger Type

Display the currently selected trigger type and trigger condition setting. Different labels are displayed when different trigger types are selected. For example:  represents triggering on the rising edge in "Edge" trigger.



9. Trigger Source

Display the trigger source currently selected (CH1, CH2, AC Line, or EXT). Different labels are displayed when different trigger sources are selected and the color of the trigger parameter area will change accordingly. For example:  denotes that CH1 is selected as the trigger source.

10. Trigger Level

- When the trigger source is set to analog channel, you need to set proper trigger level.
 -  at the right of the screen is the trigger level label and the trigger level value is displayed at the upper-right corner of the screen.
 - When using **TRIGGER**  **LEVEL** to modify the trigger level, the trigger level value will change with the up and down of .
- Note:** In slope trigger, runt trigger and windows trigger, there are two trigger level labels ( and .



11. CH1 Vertical Scale

- Display the voltage value per grid of CH1 waveform vertically.
- Use **VERTICAL**  **SCALE** to modify this parameter.
- The following labels will be displayed according to the current channel setting: channel coupling (e.g. ) and bandwidth limit (e.g. .

12. Analog Channel Label/Waveform

Different channels are marked with different colors and the colors of the channel label and waveform are the same.

13. CH2 Vertical Scale





- Display the voltage value per grid of CH2 waveform vertically.
- Use **VERTICAL**  **SCALE** to modify this parameter.
- The following labels will be displayed according to the current channel setting: channel coupling (e.g. ) and bandwidth limit (e.g. )

14. Message Box

Display prompt messages.

15. Notification Area













Display sound icon and USB disk icon.

- Sound Icon: Press **Utility**  **Sound** to enable or disable the sound. When the sound is enabled,  will be displayed; when the sound is disabled,  will be displayed.
- USB Disk Icon: when a USB disk is detected,  will be displayed.

16. Operation Menu

Press any softkey to activate the corresponding menu.



The following symbols might be displayed in the menu:

-  Denote that you can rotate the multifunction knob  to modify parameters. The backlight of  turns on during the parameter modification.
-  Denote that you can rotate  to select the desired item, the item currently selected is displayed in blue, press down the knob to enter the corresponding menu. The backlight of  is constant on after menus with this symbol are selected.
-  Denote that press  to input desired parameter values directly using the pop-up numeric keyboard. The backlight of  is constant on after menus with this symbol are selected.
-  Denote that the current menu has several options.
-  Denote that the current menu has a lower level menu.
-  Press this key to return to the previous menu.
-  The number of the dots denotes that the number of the pages the current menu has.

Parameter Setting Method

This oscilloscope provides two methods to set the basic parameters.

Method 1:

When  is displayed on the menu, you can rotate  to set the desired value directly.

Method 2:



When  is displayed, press down  and the numeric keyboard is displayed, as shown below. Rotate the knob to select the desired value, and then press down the knob to input the value. After all the value input, rotate the knob to select the desired unit, press down the knob to finish your input.



Figure 12 Numeric Keyboard

To Use the Security Lock

If needed, you can use the security lock (please buy it yourself) to lock the oscilloscope to a fixed location. The method is as follows, align the lock with the lock hole and plug it into the lock hole vertically, turn the key clockwise to lock the oscilloscope and then pull the key out.

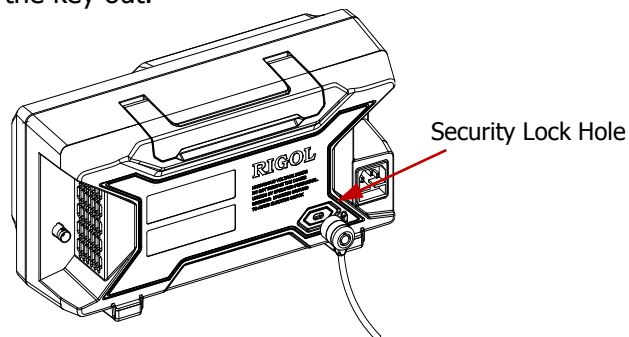

Figure 13 To Use the Security Lock

Note: Please do not insert other articles into the security lock hole to avoid damaging the instrument.

To Use the Built-in Help System

The help system of this oscilloscope provides instructions for all the function keys (including menu keys) on the front panel. Press **Help** to open the help interface and press again to close the interface. The help interface mainly consists of two parts. The left is "Help Options" and the right is "Help Display Area".

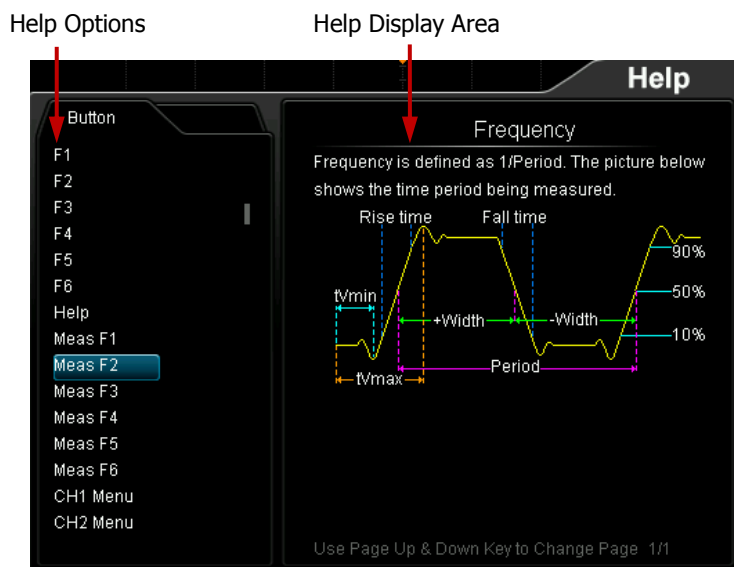





Figure 14 Help Information

You can press the button (except the Power key , the knob  and the menu Page Up/Down key ) on the front panel directly to get the corresponding help information in the "Help Display Area".

Troubleshooting

The commonly encountered failures and their solutions are listed below. When you encounter those failures, please solve them following the corresponding steps. If the problem remains still, please contact **RIGOL** and provide your device information (acquisition method: **Utility** → **System** → **System Info**).

- 1. The screen is still dark (no display) after you powered on the instrument.**
 - (1) Check whether the power switch is really on.
 - (2) Check whether the power is correctly connected.
 - (3) Check whether the fuse is burned out. If the fuse needs to be changed, please use the specified fuse.
 - (4) Restart the instrument after finishing the above inspections.
 - (5) If it still persists, please contact **RIGOL**.

- 2. The signal is sampled but no waveform of the signal is displayed.**
 - (1) Check whether the probe is correctly connected to the item under test.
 - (2) Check whether signals are generated from the item under test (you can connect the probe compensation signal to the problematic channel to locate the problem).
 - (3) Resample the signal.

- 3. The voltage amplitude measured is greater or smaller than the actual value (note that this failure usually only occurs when probe is used).**

Check whether the probe ratio of the channel complies with the attenuation ratio of the probe.

- 4. Waveforms are found to be displayed but not stable.**
 - (1) Check the trigger signal source: press **MENU** (in the trigger control area (TRIGGER) on the front panel) → **Source** to check whether the trigger source selected complies with the signal channel actually used.
 - (2) Check the trigger type: general signals should use "Edge" trigger and video signal should use "Video" trigger. Only when the proper trigger type is used, can the waveform be displayed stably.
 - (3) Check the trigger level: adjust the trigger level to the middle of the signal.
 - (4) Change the trigger holdoff setting.

- 5. No display is found after pressing **RUN/STOP**.**

Check whether the trigger mode in the trigger control area (TRIGGER) on the front panel is "Normal" or "Single" and whether the trigger level exceeds the waveform range. If yes, set the trigger level to the middle or press **MODE** to set the trigger mode to "Auto".

Note: Pressing **AUTO** could automatically finish the above setting.

6. The display of waveform is ladder-like.

- (1) The horizontal time base might be too low. Increase the horizontal time base to increase the horizontal resolution and improve the display.
- (2) If the display type is "Vectors", the lines between the sample points may cause ladder-like display. Press **Display** → **Type** to set the display type to "Dots" to solve the problem.

7. I Fail to connect PC or PictBridge printer through USB.

- (1) Press **Utility** → **IO Setting** → **USB Device** to check whether the current setting matches the device currently connected.
- (2) Check whether the USB cable is correctly connected to the instrument and PC.
- (3) Check whether the USB cable is in good condition. If needed, restart the oscilloscope.

8. The USB storage device cannot be recognized.

- (1) Check whether the USB storage device can work normally.
- (2) Check whether the USB storage device being used is flash type. This oscilloscope does not support USB3.0 and hardware type USB storage device.
- (3) Check whether the capacity of the USB storage device is too large. It is recommended that the capacity of the USB storage device being used with this oscilloscope should not exceed 8 GBytes.
- (4) Restart the instrument and then insert the USB storage device to check it.
- (5) If the USB storage device still cannot be used normally, please contact **RIGOL**.

RIGOL

快速指南

DS1000Z-E 系列数字示波器

2019 年 8 月

RIGOL (SUZHOU) TECHNOLOGIES INC.

保证和声明

版权

© 2019 苏州普源精电科技有限公司

商标信息

RIGOL 是苏州普源精电科技有限公司的注册商标。

文档编号

QGA27000-1110

声明

- 本公司产品受中国及其它国家和地区的专利（包括已取得的和正在申请的专利）保护。
- 本公司保留改变规格及价格的权利。
- 本手册提供的信息取代以往出版的所有资料。
- 本手册提供的信息如有变更，恕不另行通知。
- 对于本手册可能包含的错误，或因手册所提供的信息及演绎的功能以及因使用本手册而导致的任何偶然或继发的损失，**RIGOL** 概不负责。
- 未经 **RIGOL** 事先书面许可，不得影印、复制或改编本手册的任何部分。

产品认证

RIGOL 认证本产品符合中国国家产品标准和行业产品标准及 ISO9001:2015 标准和 ISO14001:2015 标准，并进一步认证本产品符合其它国际标准组织成员的相关标准。

联系我们

如您在使用此产品或本手册的过程中有任何问题或需求，可与 **RIGOL** 联系：

电子邮箱：service@rigol.com

网址：www.rigol.com

安全要求

一般安全概要

1. 请使用所在国家认可的本产品专用电源线。
2. 请确保产品可靠接地。
3. 正确连接探头。
4. 查看所有终端额定值。
5. 请使用合适的过压保护。
6. 请勿开盖操作。
7. 请勿将异物插入排风口。
8. 请使用合适的保险丝。
9. 避免电路外露。
10. 怀疑产品出故障时，请勿进行操作。
11. 请保持适当的通风。
12. 请勿在潮湿环境下操作。
13. 请勿在易燃易爆的环境下操作。
14. 请保持产品表面的清洁和干燥。
15. 请注意防静电保护。
16. 请注意搬运安全。

安全术语和符号

本手册中的安全术语：



警告

警告性声明指出可能会造成人身伤害或危及生命安全的情况或操作。



注意

注意性声明指出可能导致本产品损坏或数据丢失的情况或操作。

产品上的安全术语：

- DANGER** 表示您如果不进行此操作，可能会立即对您造成危害。
- WARNING** 表示您如果不进行此操作，可能会对您造成潜在的危害。
- CAUTION** 表示您如果不进行此操作，可能会对本产品或连接到本产品的其他设备造成损坏。

产品上的安全符号：



高电压



安全警告



保护性接地端



壳体接地端



测量接地端

测量类别

测量类别

DS1000Z-E 系列数字示波器可在测量类别 I 下进行测量。



警告

本示波器仅允许在指定的测量类别中使用。

测量类别定义

测量类别 I 是指在没有直接连接到主电源的电路上进行测量。例如，对不是从主电源导出的电路，特别是受保护（内部）的主电源导出的电路进行测量。在后一种情况下，瞬间应力会发生变化。因此，用户应了解设备的瞬间承受能力。

测量类别 II 是指在直接连接到低压设备的电路上进行测量。例如，对家用电器、便携式工具和类似的设备进行测量。

测量类别 III 是指在建筑设备中进行测量。例如，在固定设备中的配电板、断路器、线路（包括电缆、母线、接线盒、开关、插座）以及工业用途的设备和某些其它设备（例如，永久连接到固定装置的固定电机）上进行测量。

测量类别 IV 是指在低压设备的源上进行测量。例如，电表、在主要过电保护设备上的测量以及在脉冲控制单元上的测量。

通风要求

本示波器通过风扇强制冷却。请确保进气和排气区域无阻塞并有自由流动的空气。为保证充分的通风，在工作台或机架中使用示波器时，请确保其两侧、上方、后面应留出至少 10 厘米的间隙。



警告

通风不良会引起仪器温度升高，进而引起仪器损坏。使用时应保持有良好的通风，定期检查通风口和风扇。

工作环境

温度

操作时：0°C至+50°C

非操作时：-40°C至+70°C

湿度

0°C至+30°C：≤95%相对湿度

+30°C至+40°C：≤75%相对湿度

+40°C至+50°C：≤45%相对湿度



警告

为避免仪器内部电路短路或发生电击的危险，请勿在潮湿环境下操作仪器。

海拔高度

操作时：3000 米以下

非操作时：15000 米以下

安装（过电压）类别

本产品由符合安装（过电压）类别 II 的主电源供电。



警告

确保没有过电压（如由雷电造成的电压）到达该产品。否则操作人员可能有遭受电击的危险。

安装（过电压）类别定义

安装（过电压）类别 I 是指信号电平，其适用于连接到源电路中的设备测量端子，其中已经采取措施，把瞬时电压限定在相应的低水平。

安装（过电压）类别 II 是指本地配电电平，其适用于连接到市电（交流电源）的设备。

污染程度

2 类

污染程度定义

污染度 1：无污染，或仅发生干燥的非传导性污染。此污染级别没有影响。例如：清洁的房间或有空调控制的办公环境。

污染度 2：一般只发生干燥的非传导性污染。有时可能发生由于冷凝而造成的暂时性传导。例如：一般室内环境。

污染度 3：发生传导性污染，或干燥的非传导性污染由于冷凝而变为具有传导性。例如：有遮棚的室外环境。

污染度 4：通过传导性的尘埃、雨水或雪产生永久的可导性污染。例如：户外场所。

安全级别

1 级 - 接地产品

保养与清洁

保养

请勿将仪器放置在长时间受到日照的地方。

清洁

请根据使用情况经常对仪器进行清洁。方法如下：

1. 断开电源。
2. 用柔和的清洁剂或清水浸湿软布擦拭仪器外部，请注意不要将水或其他异物通过散热孔进入机箱内。清洁带有液晶显示屏的仪器时，请注意不要划伤 LCD 显示屏。



注意

请勿使任何腐蚀性的液体沾到仪器上，以免损坏仪器。



警告

重新通电之前，请确认仪器已经干透，避免因水分造成电气短路甚至人身伤害。

环境注意事项

以下符号表明本产品符合 WEEE Directive 2002/96/EC 所制定的要求。



设备回收

本产品中包含的某些物质可能会对环境或人体健康有害，为避免将有害物质释放到环境中或危害人体健康，建议采用适当的方法回收本产品，以确保大部分材料可正确地重复使用或回收。有关处理或回收的信息，请与当地权威机构联系。

文档概述

本文档用于指导用户快速了解DS1000Z-E系列数字示波器的前后面板、用户界面及基本操作方法。您可登录**RIGOL**官网（www.rigol.com）下载所需文档的最新版本。

文档格式的约定：

1. 按键

用“按键字符（加粗）+文本框”表示前面板功能按键，如 **Utility** 表示“Utility”按键。

2. 菜单

用“菜单文字（加粗）+字符底纹”表示一个菜单选项，如 **系统** 表示 **Utility** 按键下的“系统”菜单选项。

3. 操作步骤

用箭头“→”表示下一步操作，如 **Utility** → **系统** 表示按下前面板上的 **Utility** 按键后，再按 **系统** 菜单键。

4. 旋钮

标识	旋钮	标识	旋钮
水平  SCALE	水平档位旋钮	垂直  SCALE	通道垂直档位旋钮
水平  POSITION	水平位移旋钮	垂直  POSITION	通道垂直位移旋钮
触发  LEVEL	触发电平旋钮	——	——

文档内容的约定：

DS1000Z-E 系列包含以下型号。如无特殊说明，本手册以 DS1202Z-E 为例说明 DS1000Z-E 系列的前后面板、用户界面及基本操作方法等。

型号	模拟带宽	模拟通道数
DS1202Z-E	200 MHz	2

目录

保证和声明	I
安全要求	II
一般安全概要	II
安全术语和符号	II
测量类别	III
通风要求	III
工作环境	IV
保养与清洁	V
环境注意事项	V
文档概述	VI
快速入门	1
一般性检查	1
外观尺寸	2
使用前准备	3
调节支撑脚	3
连接电源	3
开机检查	3
连接探头	4
功能检查	5
探头补偿	6
前面板总览	7
后面板总览	8
前面板功能概述	10
垂直控制	10
水平控制	11
触发控制	11
全部清除	11
波形自动显示	12
运行控制	12
单次触发	12
多功能旋钮	12
功能菜单	13
打印	13
用户界面	14
参数设置方法	17
使用安全锁	17
使用内置帮助系统	18
故障处理	19

快速入门

一般性检查

1. 检查运输包装

如运输包装已损坏，请保留被损坏的包装或防震材料，直到货物经过完全检查且仪器通过电性和机械测试。

因运输造成仪器损坏，由发货方和承运方联系赔偿事宜。**RIGOL**公司恕不进行免费维修或更换。

2. 检查整机

若存在机械损坏或缺失，或者仪器未通过电性和机械测试，请联系您的 **RIGOL** 经销商。

3. 检查随机附件

请根据装箱单检查随机附件，如有损坏或缺失，请联系您的**RIGOL**经销商。

外观尺寸



图 1 正视图

单位: mm

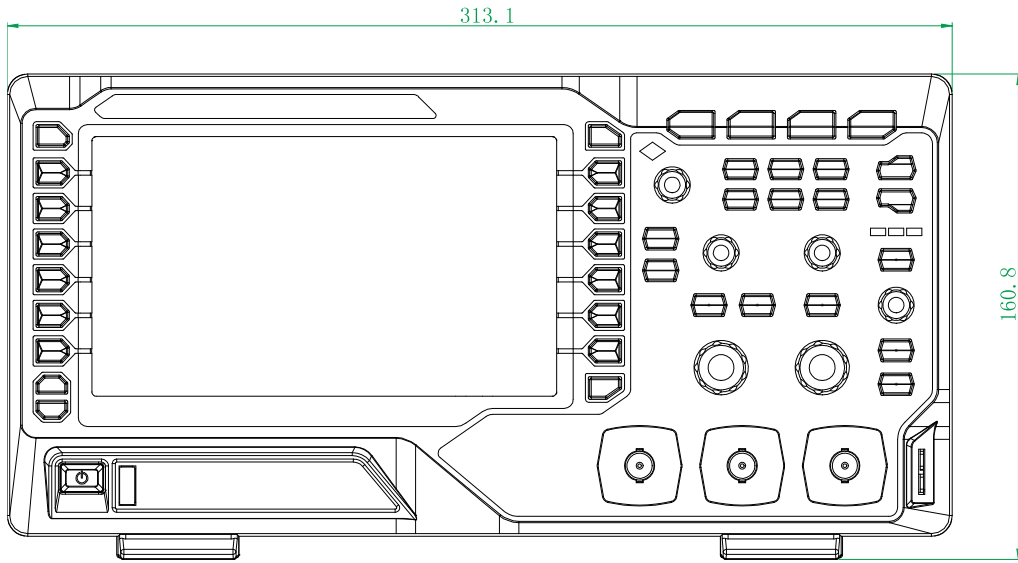

图 2 俯视图

单位: mm

使用前准备

调节支撑脚

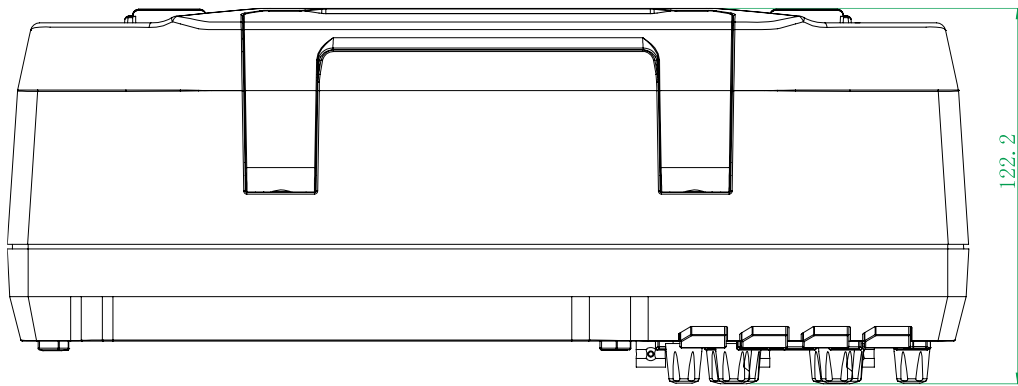
适当调整支撑脚，将其作为支架使示波器向上倾斜，以稳定放置示波器，便于更好地操作和观察显示屏。



图 3 调节支撑脚

连接电源

本示波器可输入的交流电源的规格为：100-240 V，45-440 Hz。请使用附件提供的电源线如下图所示将示波器连接至 AC 电源。



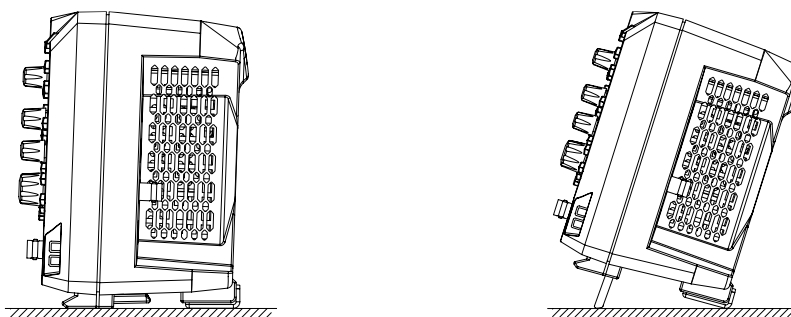

图 4 连接电源

开机检查

当示波器处于通电状态时，按前面板左下角的电源键  即可启动示波器。开机过程中示波器执行一系列自检，自检结束后出现开机画面。仪器出厂时我们将为用户提供选件的试用版本，剩余时间约为 2000 分钟。如果您的仪器当前安装了试用版本的选件，屏幕将弹出“已安装选件”对话框，您可以查看当前已安装选件的选件名称、所属模块、选件版本和剩余时间。

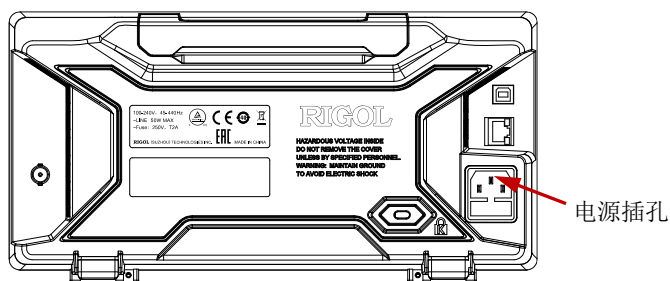
连接探头

RIGOL 为 DS1000Z-E 系列提供无源探头。探头的具体型号请参考《DS1000Z-E 系列数据手册》。有关探头的详细技术信息请参考相应的探头用户手册。

连接无源探头：

1. 将探头的 BNC 端连接至示波器前面板的模拟通道输入端。
2. 将探头接地鳄鱼夹连接至电路接地端，然后将探针连接至待测电路测试点中。



图 5 连接无源探头

连接无源探头后，您需要在测量前进行探头功能检查和探头补偿调节，具体步骤请参考本手册中“**功能检查**”和“**探头补偿**”一节介绍的内容。

功能检查

1. 按 **Storage** → **默认设置**，将示波器恢复为默认配置。
2. 将探头的接地鳄鱼夹连接至如下图所示的“接地端”。
3. 使用探头连接示波器的通道 1 (CH1) 输入端和“补偿信号输出端”。

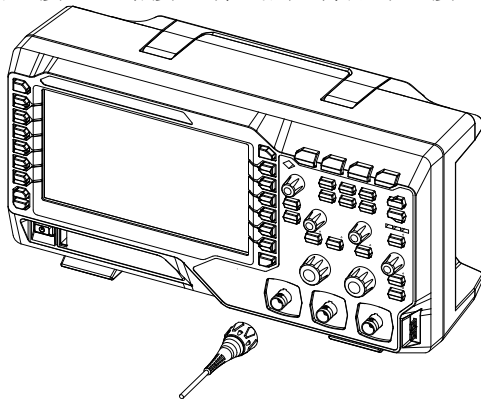

图 6 使用补偿信号

4. 将探头衰减比设定为 10X，然后按 **AUTO** 键。
5. 观察示波器显示屏上的波形，正常情况下应显示下图所示的方波：

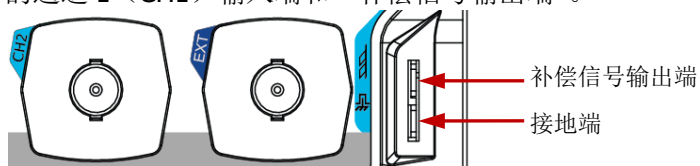

图 7 方波信号

6. 用同样方法检查其他通道。如实际显示的方波形状与上图不相符，请执行下一节“探头补偿”。

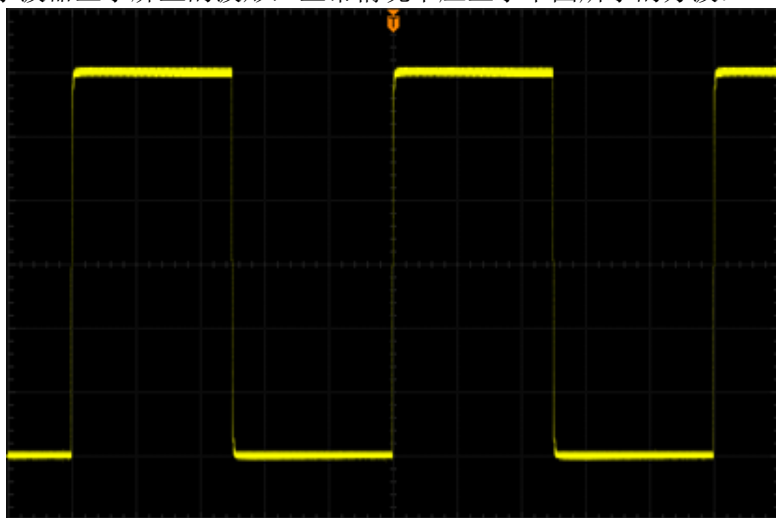

警告

为避免使用探头时被电击，请首先确保探头的绝缘导线完好，并且在连接高压源时不要接触探头的金属部分。

提示

探头补偿连接器上输出的信号仅作探头补偿调整之用，不可用于校准。

探头补偿

首次使用探头时，应进行探头补偿调节，使探头与示波器输入通道匹配。未经补偿或补偿偏差的探头会导致测量误差或错误。探头补偿步骤如下：

1. 执行上一节“**功能检查**”中的步骤 1、2、3 和 4。
2. 检查所显示的波形形状并与下图对比。



图 8 探头补偿

3. 用非金属质地的改锥调整探头上的低频补偿调节孔，直到显示的波形如上图“补偿正确”。

前面板总览

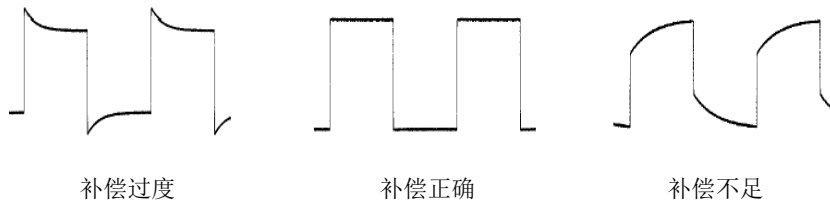

图 9 前面板总览

表 1 前面板说明

编号	说明	编号	说明
1	测量菜单操作键	10	内置帮助/打印键
2	LCD	11	电源键
3	功能菜单操作键	12	USB Host 接口
4	多功能旋钮	13	模拟通道输入
5	常用操作键	14	垂直控制区
6	全部清除键	15	水平控制区
7	波形自动显示	16	外部触发输入
8	运行/停止控制键	17	触发控制区
9	单次触发控制键	18	探头补偿信号输出端/接地端

后面板总览

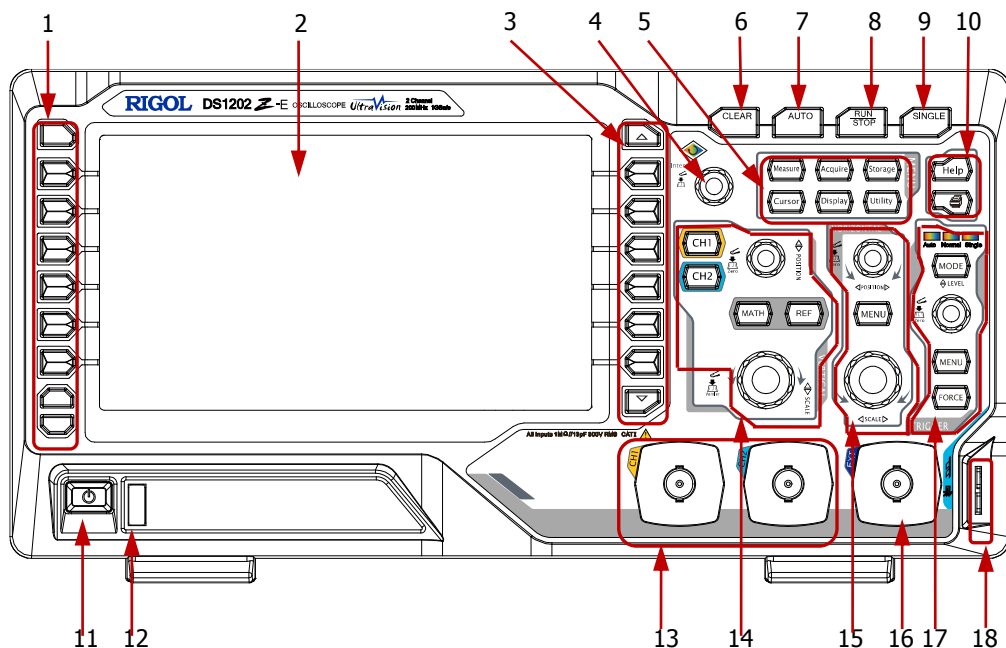

图 10 后面板总览

1. 手柄

垂直拉起该手柄，可方便提携示波器。不需要时，向下轻按手柄即可。

2. LAN

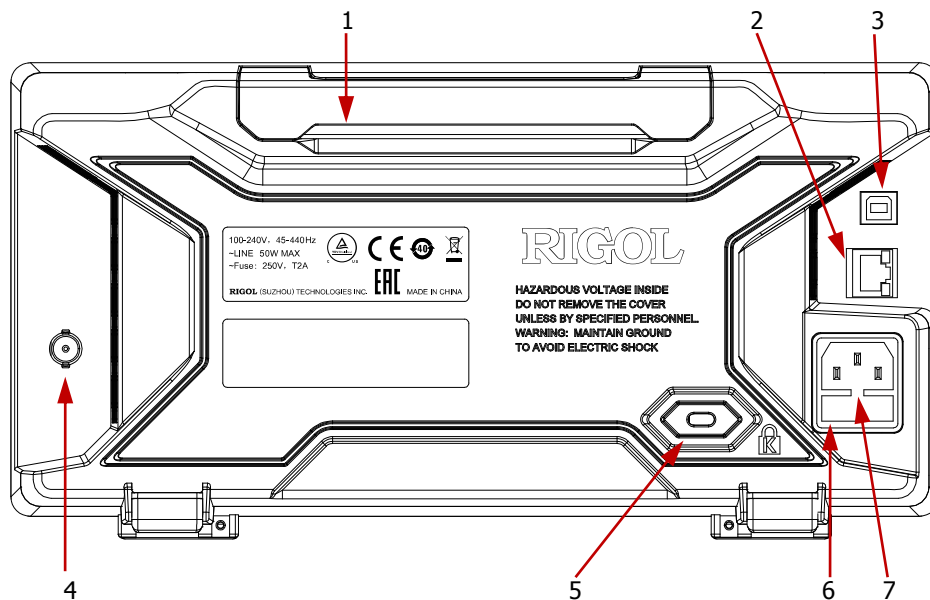
通过该接口将示波器连接到网络中，对其进行远程控制。本示波器符合 LXI CORE 2011 DEVICE 类仪器标准，可快速搭建测试系统。

3. USB DEVICE

通过该接口可将示波器连接至计算机或 PictBridge 打印机。连接计算机时，用户可通过上位机软件发送 SCPI 命令或自定义编程控制示波器。连接打印机时，用户通过打印机打印屏幕显示的波形。

4. 触发输出/通过失败

● 触发输出：

示波器产生一次触发时，可通过该接口输出一个反映示波器当前捕获率的信号，将该信号连接至波形显示设备，测量该信号的频率，测量结果与当前捕获率相同。

● 通过失败：

在通过/失败测试中，当示波器监测到一次失败时，将通过该连接器输出一个负脉冲，未监测到失败时，通过该连接器持续输出低电平。

5. 锁孔

可以使用安全锁（请用户自行购买）通过该锁孔将示波器锁定在固定位置。

6. 保险丝

如需更换保险丝，请使用符合规格的保险丝。本示波器的保险丝规格为 250V，T2A。操作方法如下：

- a) 关闭仪器，断开电源，拔出电源线。
- b) 使用小一字螺丝刀插入电源插口处的凹槽，轻轻撬出保险丝座。
- c) 取出保险丝，更换指定规格的保险丝，然后将保险丝座安装回原处。

7. AC 电源插孔

AC 电源输入端。本示波器的供电要求为 100-240 V，45-440 Hz。请使用附件提供的电源线将示波器连接到 AC 电源中，按下前面板电源键即可开机。

前面板功能概述

垂直控制

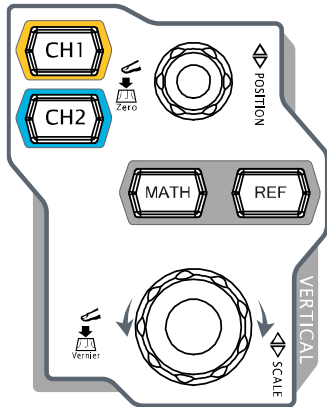

CH1、**CH2**: 模拟通道设置键。2 个通道标签用不同颜色标识, 并且屏幕中的波形和通道输入连接器的颜色也与之对应。按下任一按键打开相应通道菜单, 再次按下关闭通道。

MATH: 按 **MATH** → **Math** 可打开 $A+B$ 、 $A-B$ 、 $A \times B$ 、 A/B 、FFT、 $A \& B$ 、 $A || B$ 、 A^B 、 $!A$ 、Intg、Diff、Sqrt、Lg、Ln、Exp 和 Abs 等多种运算。按下 **MATH** 您还可以打开解码菜单, 设置解码选项。

REF: 按下该键打开参考波形功能。可将实测波形和参考波形比较。

垂直 **POSITION**: 修改当前通道波形的垂直位移。顺时针转动增大位移, 逆时针转动减小位移。修改过程中波形会上下移动, 同时屏幕左下角弹出的位移信息 (如 **POS: 216.0mV**) 实时变化。按下该旋钮可快速将垂直位移归零。

垂直 **SCALE**: 修改当前通道的垂直档位。顺时针转动减小档位, 逆时针转动增大档位。修改过程中波形显示幅度会增大或减小, 同时屏幕下方的档位信息 (如 **1 = 200mV**) 实时变化。按下该旋钮可快速切换垂直档位调节方式为“粗调”或“微调”。

提示

如何设置各通道的垂直档位和垂直位移?

DS1000Z-E 系列数字示波器的 2 个通道复用同一组 **垂直** **POSITION** 和 **垂直** **SCALE** 旋钮。如需设置某一通道的垂直档位和垂直位移, 请首先按 **CH1** 或 **CH2** 键选中该通道, 然后旋转 **垂直** **POSITION** 和 **垂直** **SCALE** 旋钮进行设置。

水平控制

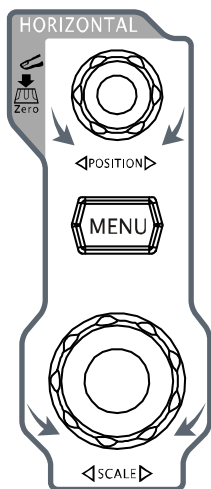

水平 **POSITION**: 修改水平位移。转动旋钮时触发点相对屏幕中心左右移动。修改过程中，所有通道的波形左右移动，同时屏幕右上角的水平位移信息（如 **D** -200.000000ns）实时变化。按下该旋钮可快速复位水平位移（或延迟扫描位移）。

MENU: 按下该键打开水平控制菜单。可开关延迟扫描功能，切换不同的时基模式。

水平 **SCALE**: 修改水平时基。顺时针转动减小时基，逆时针转动增大时基。修改过程中，所有通道的波形被扩展或压缩显示，同时屏幕上方的时基信息（如 **H** 500ns）实时变化。按下该旋钮可快速切换至延迟扫描状态。

触发控制

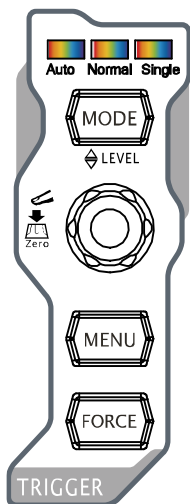

MODE: 按下该键切换触发方式为 **Auto**、**Normal** 或 **Single**，当前触发方式对应的状态背光灯会变亮。

触发 **LEVEL**: 修改触发电平。顺时针转动增大电平，逆时针转动减小电平。修改过程中，触发电平线上下移动，同时屏幕左下角的触发电平消息框（如 **Trig Level : 428mV**）中的值实时变化。按下该旋钮可快速将触发电平恢复至零点。

MENU: 按下该键打开触发操作菜单。本示波器提供丰富的触发类型，详见《DS1000Z-E 用户手册》中的介绍。

FORCE: 按下该键将强制产生一个触发信号。

全部清除



按下该键清除屏幕上所有的波形。如果示波器处于“RUN”状态，则继续显示新波形。

波形自动显示

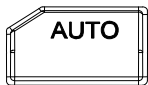

按下该键启用波形自动设置功能。示波器将根据输入信号自动调整垂直档位、水平时基以及触发方式，使波形显示达到最佳状态。

注意：应用波形自动设置功能时，若被测信号为正弦波，要求其频率不小于 41 Hz；若被测信号为方波，则要求其占空比大于 1%且幅度不小于 20 mVpp。如果不满足此参数条件，则波形自动设置功能可能无效，且菜单显示的快速参数测量功能不可用。

运行控制



按下该键“运行”或“停止”波形采样。运行（RUN）状态下，该键黄色背光灯点亮；停止（STOP）状态下，该键红色背光灯点亮。

单次触发

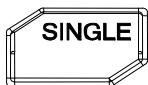

按下该键将示波器的触发方式设置为“Single”。单次触发方式下，按 **FORCE** 键立即产生一个触发信号。

多功能旋钮



调节波形亮度：

非操作时，转动该旋钮可调整波形显示的亮度。亮度可调节范围为 0%至 100%。顺时针转动增大波形亮度，逆时针转动减小波形亮度。按下旋钮将波形亮度恢复至 60%。也可按 **Display** → **波形亮度**，使用该旋钮调节波形亮度。

多功能：

菜单操作时，该旋钮背光灯变亮，按下某个菜单软键后，转动该旋钮可选择该菜单下的子菜单，然后按下旋钮可选中当前选择的子菜单。该旋钮还可以用于修改参数（具体请参考“参数设置方法”中的详细介绍）、输入文件名等。

功能菜单

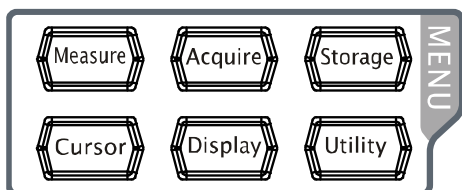

Measure: 按下该键进入测量设置菜单。可设置测量信源、打开或关闭频率计、全部测量、统计功能等。按下屏幕左侧的 **MENU**，可打开 37 种波形参数测量菜单，然后按下相应的菜单软键快速实现“一键”测量，测量结果将出现在屏幕底部。

Acquire: 按下该键进入采样设置菜单。可设置示波器的获取方式、 $\text{Sin}(x)/x$ 和存储深度。

Storage: 按下该键进入文件存储和调用界面。可存储的文件类型包括：图像存储、轨迹存储、波形存储、设置存储、CSV 存储和参数存储。支持内、外部存储和磁盘管理。

Cursor: 按下该键进入光标测量菜单。示波器提供手动、追踪、自动和 XY 四种光标模式。其中，XY 模式仅在时基模式为“XY”时有效。

Display: 按下该键进入显示设置菜单。设置波形显示类型、余辉时间、波形亮度、屏幕网格和网格亮度。

Utility: 按下该键进入系统功能设置菜单。设置系统相关功能或参数，例如接口、声音、语言等。此外，还支持一些高级功能，例如通过/失败测试、波形录制等。

打印



按下该键打印屏幕或将屏幕保存到 U 盘中。

- 若当前已连接 PictBridge 打印机，并且打印机处于闲置状态，按下该键将执行打印功能。
- 若当前未连接打印机，但连接 U 盘，按下该键则将屏幕图形以指定格式保存到 U 盘中。
- 若同时连接打印机和 U 盘时，打印机优先级较高。

用户界面

DS1000Z-E 示波器提供 7.0 英寸 WVGA (800*480) TFT LCD。



图 11 用户界面

1. 自动测量选项

提供 20 种水平 (HORIZONTAL) 测量参数和 17 种垂直 (VERTICAL) 测量参数。按下屏幕左侧的软键即可打开相应的测量项。连续按下 **MENU** 键, 可切换水平和垂直测量参数。

2. 运行状态

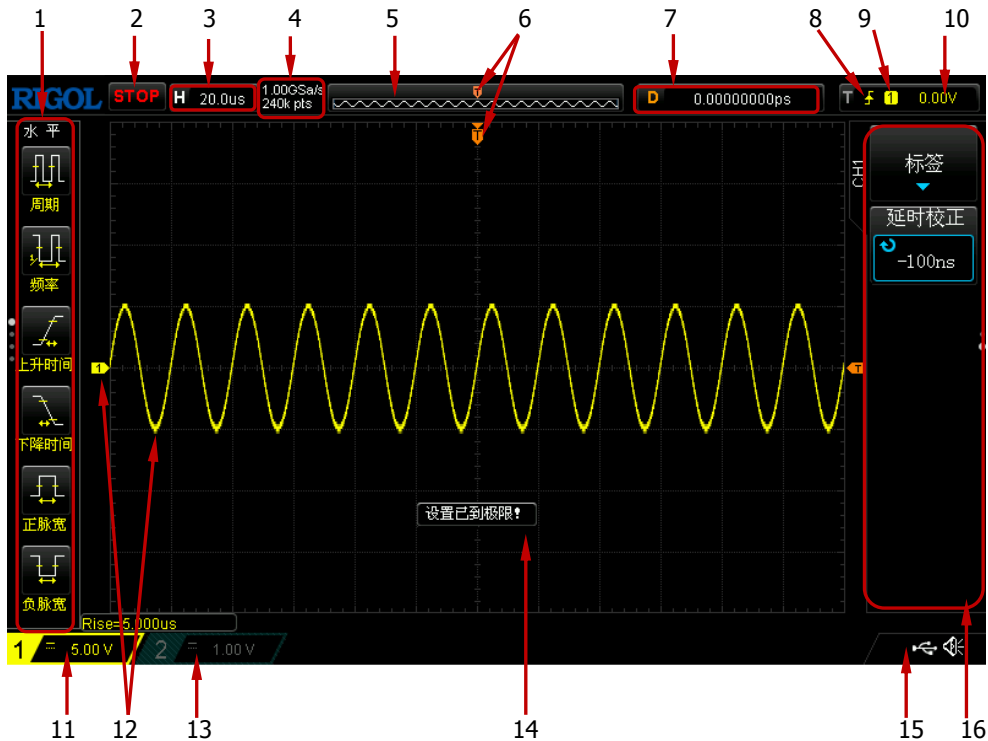
可能的状态包括: RUN (运行)、STOP (停止)、T'D (已触发)、WAIT (等待) 和 AUTO (自动)。

3. 水平时基

- 表示屏幕水平轴上每格所代表的时间长度。
- 使用水平 **SCALE** 可以修改该参数, 可设置范围为 5 ns 至 50 s。

4. 采样率/存储深度

- 显示当前示波器使用的采样率以及存储深度。
- 采样率和存储深度会随着水平时基的变化而改变。

5. 波形存储器

提供当前屏幕中的波形在存储器中的位置示意图。

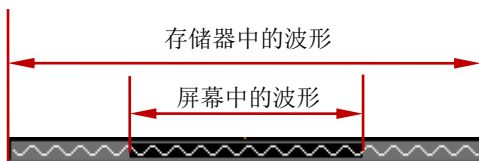

6. 触发位置

显示波形存储器和屏幕中波形的触发位置。

7. 水平位移

使用水平 **POSITION** 可以调节该参数。按下旋钮时参数自动设置为 0。

8. 触发类型

显示当前选择的触发类型及触发条件设置。选择不同触发类型时显示不同的标识。

例如， 表示在“边沿触发”的上升沿处触发。

9. 触发源

显示当前选择的触发源（CH1、CH2、AC 或 EXT）。选择不同触发源时，显示不同的标识，并改变触发参数区的颜色。

例如， 表示选择 CH1 作为触发源。

10. 触发电平

- 触发信源选择模拟通道时，您需要设置合适的触发电平。
- 屏幕右侧的 为触发电平标记，右上角为触发电平值。
- 使用触发 **LEVEL** 修改触发电平时，触发电平值会随 的上下移动而改变。

注意：斜率触发、欠幅脉冲触发和超幅触发时，有两个触发电平标记（ 和 ）。

11. CH1 垂直档位



- 显示屏幕垂直方向 CH1 每格波形所代表的电压。
- 按 选中 CH1 通道后，使用垂直 **SCALE** 可以修改该参数。
- 此外还会根据当前的通道设置给出如下标记：通道耦合（如 ）、带宽限制（如 ）。

12. 模拟通道标记/波形

不同通道用不同的颜色表示，通道标记和波形的颜色一致。

13. CH2 垂直档位

- 显示屏幕垂直方向 CH2 每格波形所代表的电压。
- 按 选中 CH2 通道后，使用垂直 **SCALE** 可以修改该参数。

- 此外还会根据当前的通道设置给出如下标记：通道耦合（如）、带宽限制（如）。

14. 消息框

显示提示消息。















15. 通知区域

显示声音图标和 U 盘图标。

- 声音图标：按 **Utility** → **声音** 可以打开或关闭声音。声音打开时，该区域显示 ；声音关闭时，显示 。
- U 盘图标：当示波器检测到 U 盘时，该区域显示 。

16. 操作菜单



按下任一软键可激活相应的菜单。下面的符号可能显示在菜单中：

-  表示可以旋转多功能旋钮  修改参数值。多功能旋钮  的背光灯在参数修改状态下变亮。
-  表示可以旋转多功能旋钮  选择所需选项，当前选中的选项显示为蓝色，按下  进入所选项对应的菜单栏。带有该符号的菜单被选中后， 的背光灯常亮。
-  表示按下  将弹出数字键盘，可直接输入所需的参数值。带有该符号的菜单被选中后， 的背光灯常亮。
-  表示当前菜单有若干选项。
-  表示当前菜单有下一层菜单。
-  按下该键可以返回上一级菜单。
-  圆点数表示当前菜单的页数。

参数设置方法

DS1000Z-E 支持通过如下两种方法设置参数。

方法一：

对于菜单上显示  的参数，直接旋转多功能旋钮  即可设置所需的数值。

方法二：



对于菜单上显示  的参数，按下多功能旋钮 ，弹出如下图所示的数字键盘。旋转旋钮选择所需的数值，按下旋钮输入该数值。输入全部数值后，旋转旋钮选择所需的单位，按下旋钮即可完成参数设置。



图 12 数字键盘

使用安全锁

如有必要，您可以使用安全锁（请自行购买）将示波器锁在固定位置。方法如下，沿与后面板垂直的方向对准锁孔将锁头插入，顺时针旋转钥匙锁定示波器，然后拔出钥匙。



图 13 使用安全锁



注意：请勿将其它物品插入安全锁孔以免损坏仪器。

使用内置帮助系统

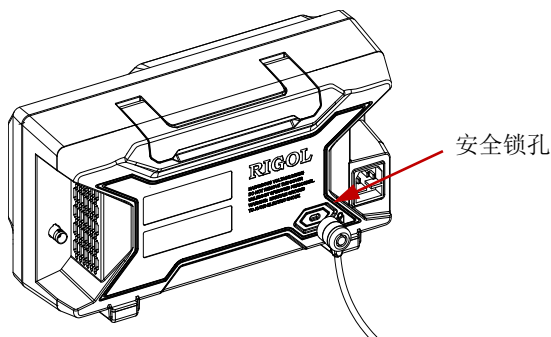
本示波器的帮助系统提供了前面板各功能键（包括菜单键）的说明。按 **Help** 键打开帮助界面，再次按下则关闭。帮助界面主要分两部分，左边为“帮助选项”，右边为“帮助显示区”。



图 14 帮助信息

您可以直接按面板上的按键（电源键 、多功能旋钮  和菜单翻页键  除外）即可在“帮助显示区”中获得相应的帮助信息。

故障处理

下面列举了示波器在使用过程中可能出现的故障及排查方法。当您遇到这些故障时，请按照相应的步骤进行处理，如不能处理，请与 **RIGOL** 联系，同时请提供您机器的设备信息（获取方法：**Utility** → **系统** → **系统信息**）。

1. 如果按下电源键示波器仍然黑屏，没有任何显示：

- (1) 检查电源开关是否打开。
- (2) 检查电源接头是否接好。
- (3) 检查保险丝是否熔断。如需更换保险丝，请使用符合本产品规格的保险丝。
- (4) 做完上述检查后，重新启动仪器。
- (5) 如果仍然无法正常使用本产品，请与 **RIGOL** 联系。

2. 采集信号后，画面中并未出现信号的波形：

- (1) 检查探头是否与示波器和待测物正常连接。
- (2) 检查待测物是否有信号产生（可将探头补偿输出信号连接到有问题的通道确定是通道还是待测物的问题）。
- (3) 再重新采集信号一次。

3. 测量的电压幅度值比实际值大或者小（一般在使用探头时才会出现）：

检查通道的探头比设置是否与实际使用的探头衰减比例相符。

4. 有波形显示，但不能稳定下来：

- (1) 检查触发信源：按前面板触发控制区（TRIGGER）的 **MENU** → **信源**，确认所选的触发信源是否与实际使用的信号通道相符。
- (2) 检查触发类型：一般的信号应使用“边沿触发”方式，视频信号应使用“视频触发”方式。只有应用适合的触发方式，波形才能稳定显示。
- (3) 检查触发电平：将触发电平调整至信号的中间位置。
- (4) 改变触发释抑设置。

5. 按下 **RUN/STOP** 键无任何显示：

检查前面板触发控制区（TRIGGER），确认触发方式是否为“普通”或“单次”档，且触发电平是否超出波形范围。如果是，将触发电平居中或者按 **MODE** 将触发方式设置为“自动”档。

注：使用自动设置 **AUTO** 按钮可自动完成以上设置。

6. 波形显示呈阶梯状：

- (1) 水平时基档位可能过低，增大水平时基以提高水平分辨率，可以改善显示。
- (2) 若显示类型为“矢量”，采样点间的连线，可能造成波形阶梯状显示。按 **Display** → **显示类型**，设置为“点”显示方式，即可解决。

7. 通过 USB 连接 PC 或 PictBridge 打印机失败:

- (1) 按 **Utility** → **接口设置** → **USB 设备**，检查当前设置是否与当前连接的设备匹配。
- (2) 检查 USB 数据线是否与示波器和 PC 连接正常。
- (3) 检查 USB 数据线是否完好，必要时重启示波器。

8. U 盘不能被识别:

- (1) 检查 U 盘是否可以正常工作。
- (2) 确认使用的为 Flash 型 U 盘，本仪器不支持 USB3.0 的 U 盘和硬盘型 U 盘。
- (3) 确认使用的 U 盘容量是否过大，本示波器推荐使用不超过 8 GBytes 的 U 盘。
- (4) 重新启动仪器后，再插入 U 盘设备进行检查。
- (5) 如果仍然无法正常使用 U 盘，请与 **RIGOL** 联系。